

NOTICE

Portions of this appendix may not fully reflect the current ADA regulations. The [regulation implementing title II](#) of the ADA was revised as recently as 2016. Revised [ADA Standards for Accessible Design \(2010 Standards\)](#) were issued on September 15, 2010 and went into effect on March 15, 2012. Additional related information can be found in the Department of Justice/Department of Transportation joint [2013 publication](#) and [2015 publication](#).

ADA Accessibility Survey Instructions: Curb Ramps

1

[§ 4.7.3]

Only measure the width of the ramp section of the curb ramp (labeled “ramp” to the right). The ramp section of a curb ramp is also known as the “ramp run.” If the curb ramp has flared sides, which can also be seen in the illustration to the right, do not include them in the measurement. The ramp run must be at least 36 inches wide.

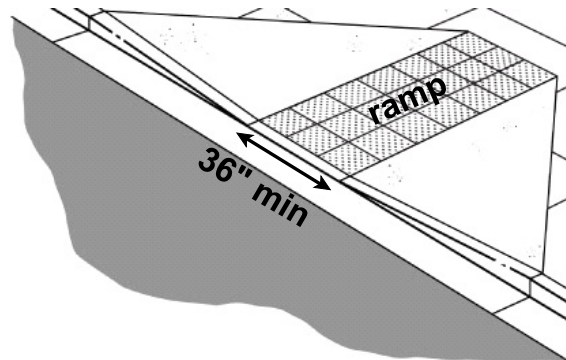

2

[§§ 4.7.2; 4.8.2; 4.1.6(3)(a)]

The running slope of the curb ramp is the slope in the direction that people travel when going up or down the ramp run. The arrow in the illustration to the left, aligned parallel to the ramp run and perpendicular to the curb, shows where to measure the running slope.

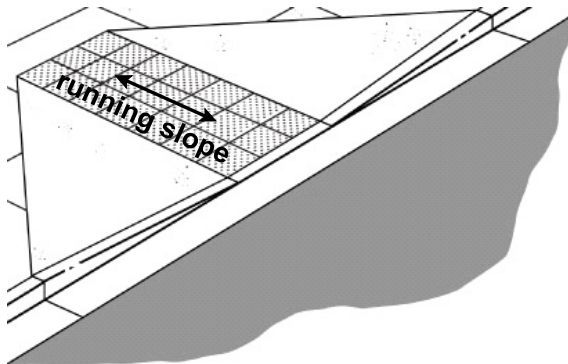

For new construction (when the curb ramp was built after January 26, 1991), the running slope of the ramp run must not exceed 8.33 percent. For alterations (when the curb ramp was altered after January 26, 1991), the slope must not exceed 10 percent for a 6-inch rise or 12.5 percent for a 3-inch rise.

3

[§ 4.3.7]

The cross slope of the curb ramp is perpendicular to the running slope. Unlike the running slope, which runs along the ramp, the cross slope is measured *across* the ramp. The arrow in the illustration to the right, aligned perpendicular to the ramp run and parallel to the curb, shows where to measure the cross slope. The cross slope of a curb ramp, or any accessible route, may not exceed 2 percent.

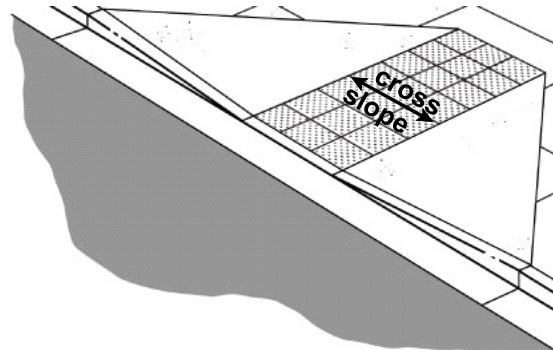

The gutter is the part of the street that borders the curb. To measure the gutter slope, place the level in the same position as the arrow in the illustration, with one end where the gutter meets the ramp and the other end towards the street. The gutter slope is parallel to the ramp and perpendicular to the curb. The gutter may slope up to 5 percent towards the curb ramp, but not more.

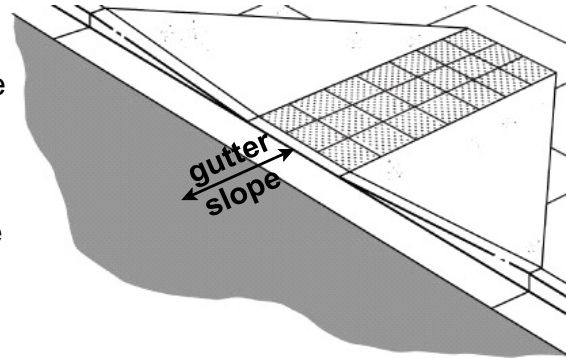

The transitions on and off the curb ramp are the points where the gutter meets the bottom of the ramp and where the top of the ramp meets the sidewalk. These transition points are required to be flush and cannot have any abrupt level changes. Record any level change at the transitions.

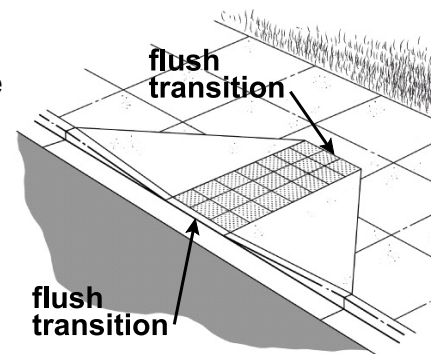

Detectable warnings are dome-shaped bumps that should cover the entire width and depth of the ramp run. Detectable warnings are designed to be felt underfoot or with a cane by people who are blind or have low vision, thereby alerting them of hazards – mainly, the transition from a pedestrian-only area to a roadway.

If the curb ramp you are surveying has detectable warnings but they do not cover the entire ramp run, explain how they are different in the “Comments” section at the bottom of the form. For curb ramps along public streets, the U.S. Department of Transportation (DOT) has deemed permissible a strip of detectable warnings that stretches across the width of the ramp run but covers only the two feet nearest the road. If the curb ramp you are surveying is located along a public street, you may circle "Y" if the detectable warnings comply with the DOT's design.

Curb ramps must be located where they will not be obstructed by parked vehicles. If the curb ramp you are surveying is along a public right-of-way or at a pedestrian crossing, vehicles should be prohibited from parking directly in front of the curb ramp on the street. If the curb ramp you are surveying is part of the accessible route from a parking lot to a building, the curb ramp may not lead into a parking space because the curb ramp will be obstructed when a vehicle parks in the space.

Curb ramps should have at least 36 inches of clear space at the “top” of the ramp, which can be seen in the illustration to the right. The 36-inch space at the top of the ramp allows pedestrians who are continuing along the sidewalk to bypass the curb ramp without traveling over it.

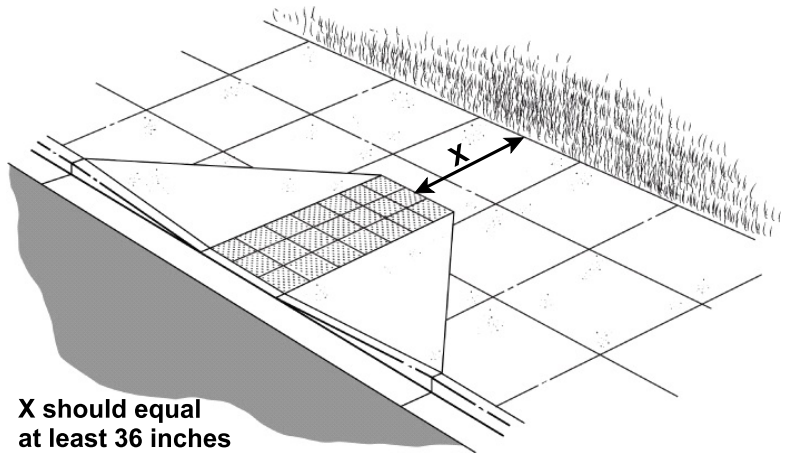

The measurement should extend from where the ramp run meets the level sidewalk (at the lower end of the arrow) to the opposite edge of the sidewalk (where the sidewalk meets the grass). Do not include any part of the curb ramp in this measurement.

Curb ramps either have flared sides or vertical edges called returned curbs. Using the illustrations below, determine whether the curb ramp you are surveying has flared sides or returned curbs and answer accordingly. The next two questions relate to the slope of flared sides, and you should answer them only if you determine your curb ramp has flared sides. If your curb ramp has returned curbs, skip to question 10.

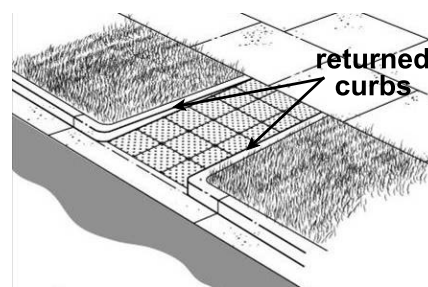
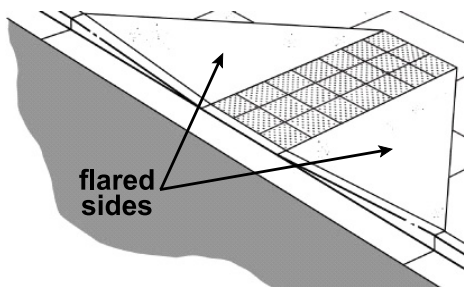

9.a

[§ 4.7.5]

If the sidewalk at the top of the ramp (“x” in the illustration) is 48 inches wide or more, answer this question. If “x” is less than 48 inches, skip this question and answer the next one.

To answer this question you need to determine the slope of the flared sides to make sure it is 10 percent or less.

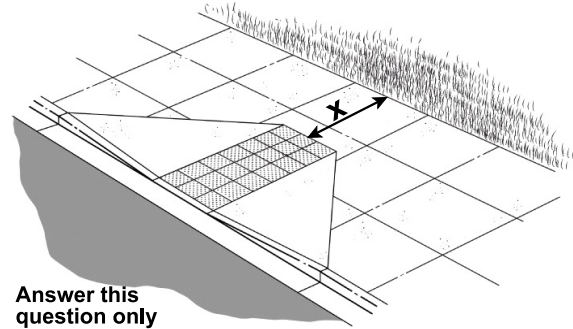

Answer this question only if X = 48" or more

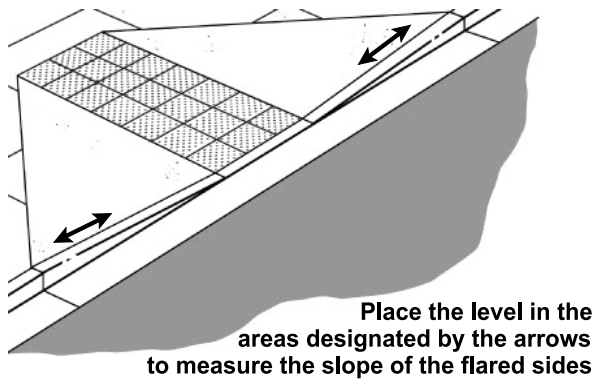

Place the level in the areas designated by the arrows to measure the slope of the flared sides

To measure the slope of a curb ramp’s flared side, place a level on the flared side near the edge of the curb. The level should be placed so that it is parallel to the curb. Place the level in the same position and location as each of the arrows in the illustration to the left.

9.b

[§ 4.7.5]

If the sidewalk at the top of the ramp (“x”) is less than 48 inches wide and the curb ramp you are surveying has flared sides, answer this question. Otherwise, skip this question.

To measure the slope of the curb ramp’s flared side, place a level on the flared side near the edge of the curb. The level should be placed so that it is parallel to the curb.

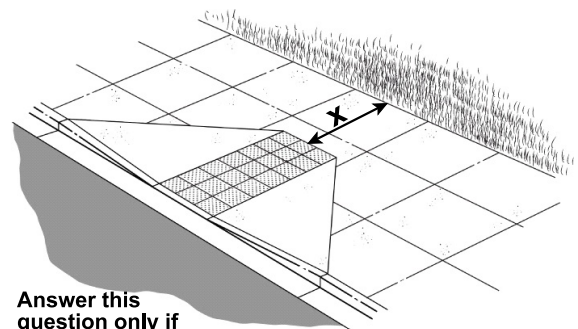

Answer this question only if X is less than 48"

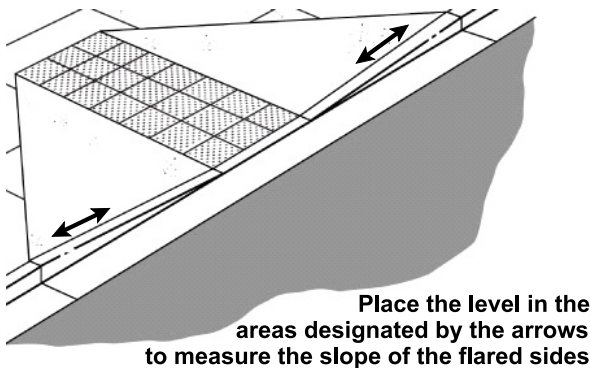

Place the level in the areas designated by the arrows to measure the slope of the flared sides

Place the level in the same position and location as each of the arrows in the illustration to the left. The slope of the curb ramp’s flared sides may not exceed 8.33 percent when there is less than 48 inches between the top of the curb ramp and the edge of the sidewalk at the other side (“x”).

Answer this question only if you skipped the previous two questions because the curb ramp you are surveying does not have flared sides.

Curb ramps must have flared sides unless pedestrians would not normally walk across the ramp. A curb ramp may have returned curbs if it has non-walking surfaces (such as grass) or obstructions on both sides because these conditions would normally discourage pedestrians from walking across the ramp.

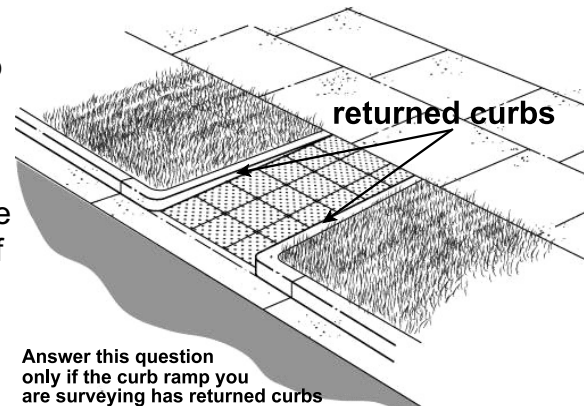

Generally, an object will qualify as an obstruction if it is immovable and is large enough to make it unlikely that pedestrians will walk across the ramp.

A built-up curb ramp typically consists of asphalt or concrete that is poured and shaped into a ramp that runs at a 90-degree angle away from an intact curb down to the roadway.

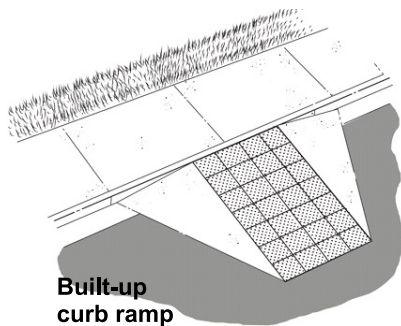

Built-up curb ramps cannot project into the path of cars. The “path of cars” includes anywhere cars are allowed to drive, including roadways, parking lot driveways, parking spaces, and access aisles.

Built-up curb ramps should have flared sides with a slope of 10 percent or less or have edge protection and handrails on the sides.

When a curb ramp is located at a marked crossing, the area where the ramp run ends must be contained within the marked crossing. The flared sides of a curb ramp do not have to be within the marked crossing.

A corner-type curb ramp is located at the center (or apex) of a corner and is often aligned to direct users into the middle of an intersection. As the illustration on the right shows, the alignment of a corner-type curb ramp means that people who travel down the ramp might be near the path of vehicular traffic once they enter the street. Therefore, if a marked crossing or crosswalk is provided, there must be a 48-inch deep area contained within the markings at the bottom of the ramp to protect people after they descend the ramp.

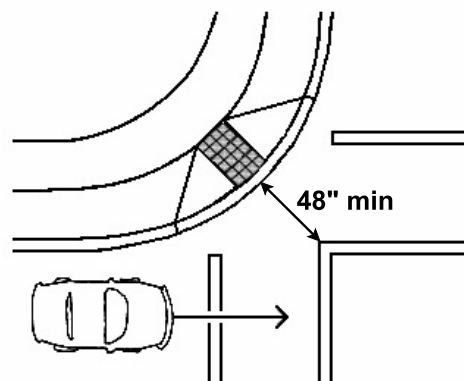

When taking this measurement, the measuring tape should be aligned parallel to the ramp run itself and should stretch from the intersection of the ramp and gutter to the innermost edge of the pavement marking.